



---

## CapFlex PIP

A real surface replacement!



reddot award 2016  
winner



In the field of hand surgery we not only offer you solutions for standard restorations, but also products for unusual and difficult situations. We therefore regard ourselves as being a true highly specialized partner in all matters relating to hand surgery with our intelligent system solutions.

## CapFlex PIP

### A real surface replacement!

Arthrosis of the proximal interphalangeal joints (PIP joints) is a frequent joint disorder that involves considerable limitations in everyday activity and in many cases pain.

Since the PIP joints are responsible for about 40% of the overall mobility of the finger, good function of the same is very important. As opposed to the distal interphalangeal joint, where arthrodesis is currently the surgical procedure of choice, movement-preserving surgery using an artificial joint is usually preferred in the case of the PIP joint.

For this application a new, innovative joint replacement is now available: CapFlex PIP. The sliding surface prosthesis, which is made of a combination of metal and polyethylene, provides proximal interphalangeal joints destroyed by arthrosis or an accident with a high degree of stability and mobility.

*Funded by the Federal Ministry of Economics and Technology  
on the basis of a resolution passed by the German Bundestag.*

CapFlex PIP: A real surface replacement!





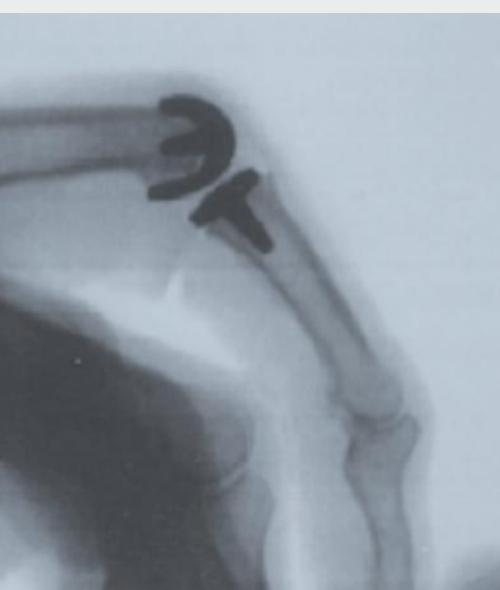

## Table of contents

	Pages
CapFlex Product Features	6-9
Indications and Surgical Techniques	10-27
■ Endoprosthesis treatment of the proximal interphalangeal joint - Dorsal approach	12-19
■ Endoprosthesis treatment of the proximal interphalangeal joint - Palmar approach	20-27
CapFlex Product Range	
■ CapFlex PIP Implants	28-29
■ CapFlex PIP Instruments	30-37
■ CapFlex PIP Storage System	38-39

## Feature, Function and Benefit



The individual components can be combined as follows:	CapFlex PIP proximal S	CapFlex PIP proximal M	CapFlex PIP proximal L
CapFlex PIP, <b>distal, S</b> , height 2.1 mm CapFlex PIP, <b>distal, S</b> , height 3.0 mm			
CapFlex PIP, <b>distal, M</b> , height 2.1 mm CapFlex PIP, <b>distal, M</b> , height 3.0 mm CapFlex PIP, <b>distal, M</b> , height 4.4 mm			
CapFlex PIP, <b>distal, L</b> , height 2.1 mm CapFlex PIP, <b>distal, L</b> , height 3.0 mm CapFlex PIP, <b>distal, L</b> , height 4.4 mm			

The CapFlex PIP prosthesis is comprised of a proximal component and a distal component. The proximal prosthetic component is made of cobalt-chrome. The inner surfaces and the spikes are coated with pure titanium to ensure optimal osseointegration. The distal component is also made of cobalt-chrome with a pure titanium coating and has an articular surface made of ultra-high molecular polyethylene (UHMWPe).

Both components are available in sizes S, M, and L.

In clinical use it often happens that for anatomical reasons the proximal component selected has to be smaller than the distal one. The proximal component selected should be as small as possible to prevent soft tissue irritation. The distal component selected should be as large as possible to prevent the implant from subsidence.

To fulfill this requirement the CapFlex PIP system permits modular use of the prosthetic components (see table above).

To be able to individually adjust the ligaments to the biomechanically correct tension the distal component is available in three different heights: 2.1 mm, 3.0 mm, and 4.4 mm (thickness of the polyethylene insert differs).

## CapFlex PIP Prosthesis

### Features

### Benefits



- Large supporting bone surfaces due to the anatomical design of the prosthesis and modular use capability of the prosthetic components

- Rapid osseointegration
- High primary stability



- Preservation of collateral ligaments due to minimal bone resection

- High postoperative stability



- Condylar guidance over the entire amplitude of movement

- Better lateral stability – important especially when treating the index and middle fingers, which are subjected to continuous lateral loading by the thumb



- Short spikes

- Best possible conditions for revision



- Metal/polyethylene articulating surfaces

- Has been a proven combination in endoprosthetics for decades
- Minimal abrasion
- Favorable sliding properties

## Feature, Function and Benefit



To ensure easy and efficient handling the CapFlex PIP instruments are consistently color-coded.

Color code	Size
Yellow	S
Blue	M
Pink	L

To distinguish the proximal and distal instruments that are required for implanting the proximal and distal components of the prosthesis, the ergonomically designed silicone handles of the various instruments are in different colors.

Handle color	Instrument type
Black	Proximal
Gray	Distal

In addition, the cap on the handle of the instrument has a "P" for a proximal instrument or a "D" for a distal instrument.

In developing the storage system the focus was not only on easy handling but also on reprocessing requirements. The drawer system of storage enables equally optimal access to all sizes of instrument.



# CapFlex PIP Instruments and Storage System

## Features

## Benefits

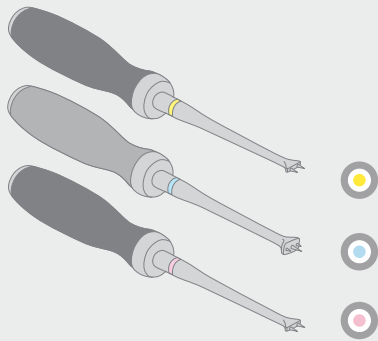

- Color-coded instruments
  - Size S: yellow
  - Size M: blue
  - Size L: pink
- Different handle color
  - Black handle: proximal instruments
  - Gray handle: distal instruments

- Easy identification of the various instruments

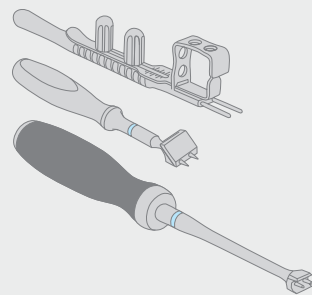

- Special instruments (saw guides and modulator) for reliable step-by-step implantation

- Axially correct implantation of the prosthesis
- Precision precontouring of prosthesis seat

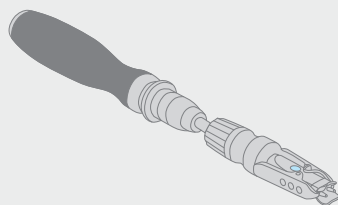

- Instrument for inserting the proximal prosthetic component without interfering with the sliding surfaces

- Axially correct implantation of the proximal prosthetic component without downward tilt
- Preservation of the sliding surfaces

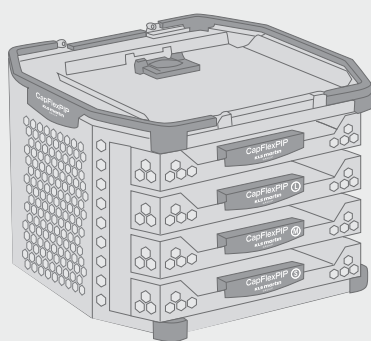

- Stainless steel drawer-based storage container of honeycomb design combined with high-performance plastic

- High stability but low weight
- Good rinsing results due to large openings
- No water residues
- Equally optimal access to all sizes
- Reduced space required

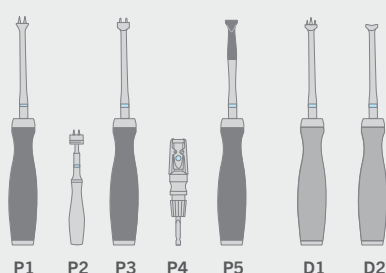

- Instruments are arranged according to the sequence of use in surgery

- Swift and intuitive supply of instruments during surgery
- User-friendly, efficient provision of instruments

## Step by Step to Optimal Treatment

### Indications

The CapFlex PIP prosthesis is used for the treatment of painfully destroyed proximal interphalangeal joints due to

- initially degenerative, secondary or post-traumatic osteoarthritis
- an inflammatory rheumatic primary disease with low inflammatory activity and a good bone situation



## Surgical Techniques

### **Endoprosthetic treatment of the proximal interphalangeal joint**

Dorsal approach  
Dr. D. Herren,  
Dr. S. Schindele

Pages 12-19

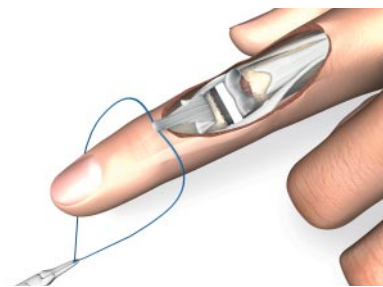

### **Endoprosthetic treatment of the proximal interphalangeal joint**

Palmar approach  
Dr. D. Herren,  
Dr. S. Schindele

Pages 20-27

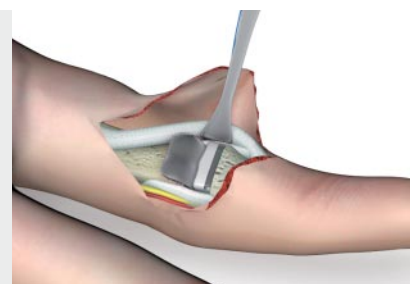



#### Preoperative planning

First of all, standard X-rays of the entire hand are taken in the A/P plane, with the hand in neutral position. Besides x-rays of the affected finger are taken in the lateral plane.

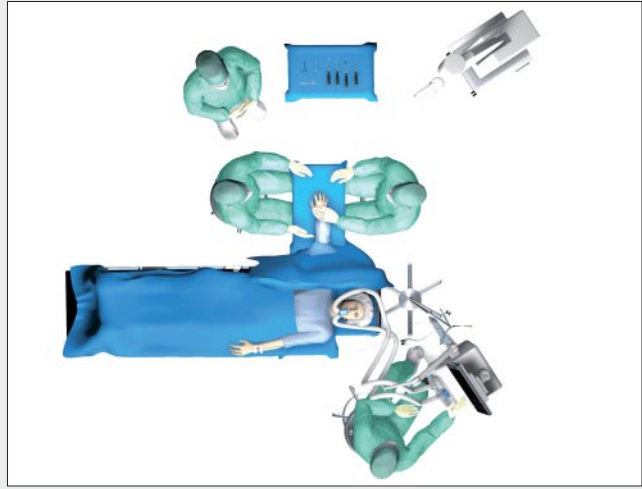

#### Patient positioning

The patient is placed in the supine position on the operating table. The hand to be operated on is placed on the extension table in the pronation position of the lower arm, with the upper arm completely deprived of blood.

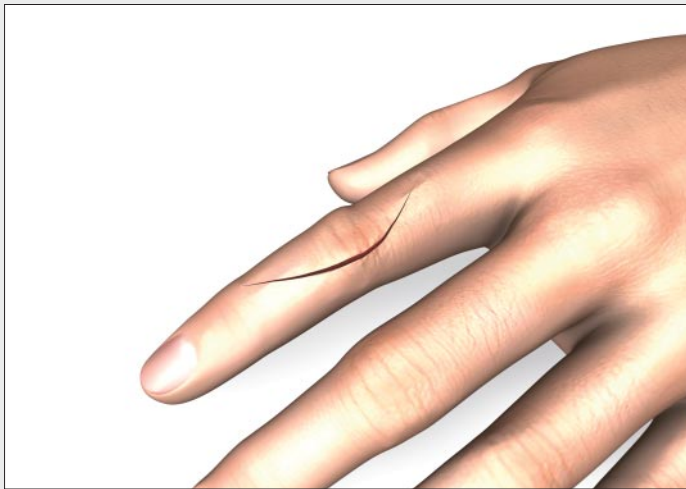

### Dorsal skin incision (straight/curved)

The extensor tendons are exposed dorsally over the PIP joint using a straight or slightly curved incision.

#### *Chamay's dorsal approach:*

A triangular strip of the central slip is cut toward proximal. It is important to prevent the insertion of the tendon flap from becoming detached from the dorsal middle phalanx.

#### *Splitting the central slip:*

A long longitudinal incision is made in the central slip. To obtain a good overview of the joint the attachment of the central slip must be laterally detached slightly from the base of the middle phalanx. At the end of the operation this detached part can be reinserted again without too high tension by a transosseous procedure.

#### *Exposure of the joint*

When the joint capsule has been opened, the dorsal osteophytes are removed and, if necessary, a synovectomy is performed.

Resection of the articular surfaces must be conducted in such a way that the collateral ligaments can remain as intact as possible. In the event of highly contracted joints with limited joint mobility arthrolysis can be performed by partial detachment of the collateral ligaments.

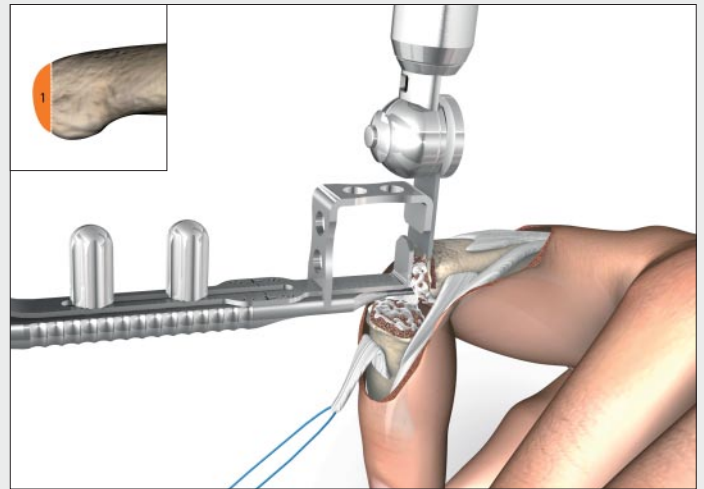

### Resection of the articular surface of the proximal phalanx

The saw guide is advanced as far as it will go from distal over the palmar guide rail under the proximal phalanx. Axial orientation must be correct.



By undoing the wing nuts the saw guide can be adjusted so the joint portion to be removed can be determined.

Resection of the distal articular surface from the proximal phalanx should be kept as minimal as possible. Based on experience, approximately 4 mm must be removed.

Using a motorized saw the distal articular surface of the proximal phalanx is removed. In doing so, the saw guide serves to guide resection and it is removed as soon as saw blade guidance proves to be good. Resection is then completed freehand.



Dorsal saw guide

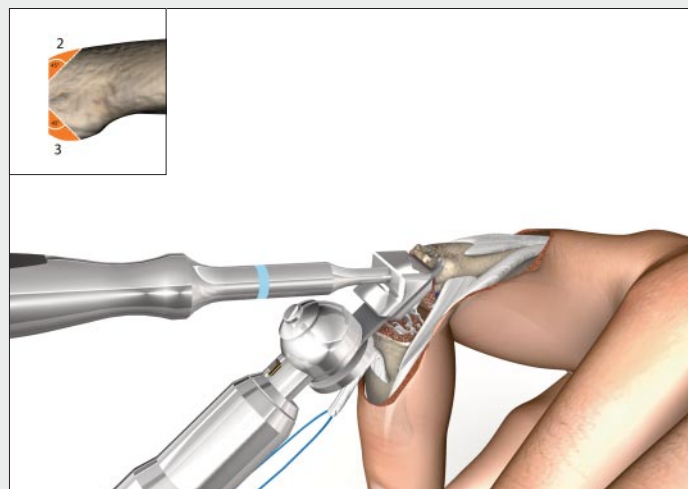
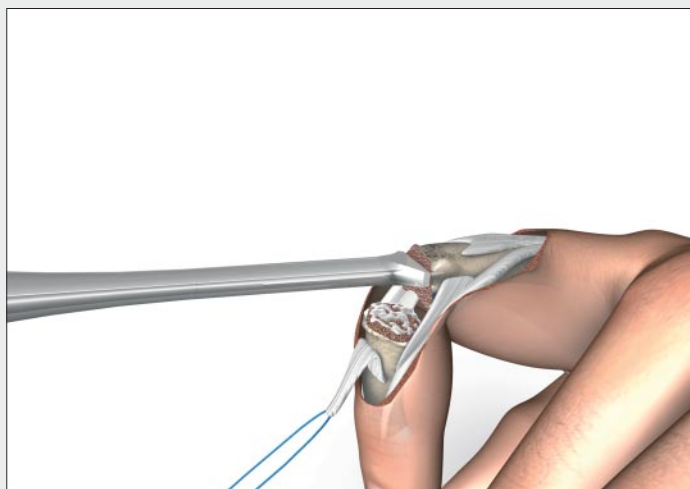

#### Determining the size of the proximal prosthetic component

To optimally determine the proximal size of the prosthesis the special size determination instrument (2 spikes) is inserted into the bone. The sizer is available in all sizes (S, M, L).

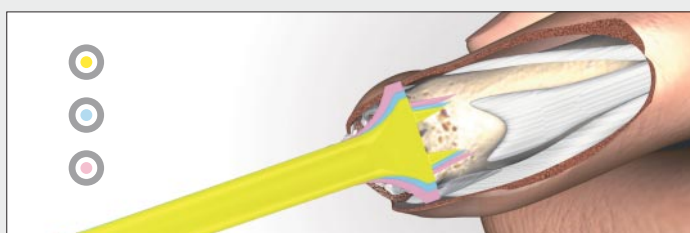

Determination of prosthesis size primarily depends on the width of the bone.

The proximal component should be kept as small as possible in order to prevent soft tissue irritation.

#### Precontouring of proximal prosthesis seat

When the proximal prosthesis size has been determined, two more steps are performed on the proximal phalanx.

For this purpose the 45° saw log is inserted in the bone via the existing stitch channel. A saw blade  $\leq 0.5$  mm thick is introduced via the guide slot in the saw log. Bone is removed on the dorsal and palmar sides, each at an angle of 45°.

In addition, any remaining palmar osteophytes can now be removed.



Sizer proximal

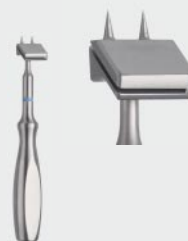

45° saw log proximal

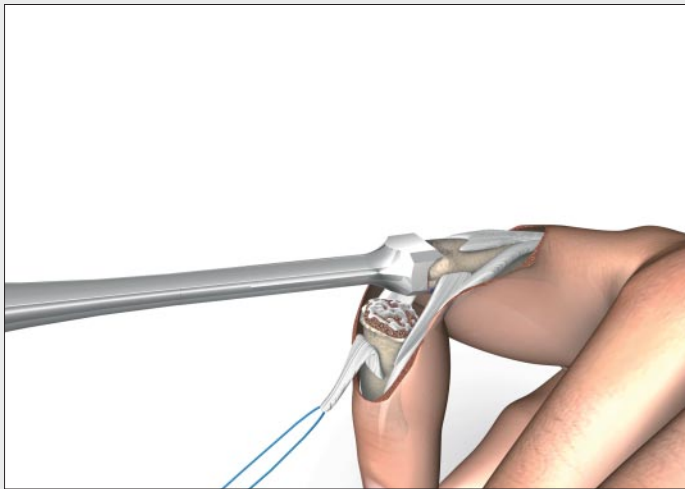

### Finishing the proximal prosthesis seat

Using the modulator, which has the internal contour of the proximal prosthetic component, a precision-fit prosthesis seat is prepared and modeled.

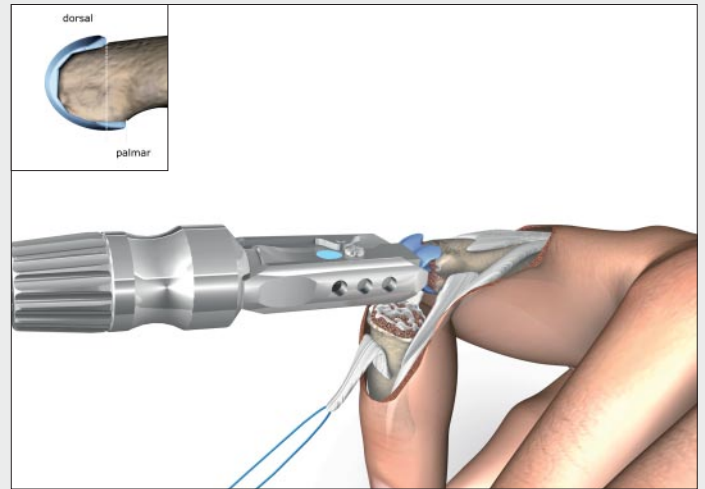

### Inserting the proximal trial prosthesis

Using the positioner, which prevents the implant from tilting downward, the proximal trial prosthesis is inserted in the axially correct position.

To avoid placing the component in an incorrect position, it is essential that the recess between the condyles be dorsal.

As soon as the trial prosthesis is seated correctly on the bone, the positioner is removed and the entire component is implanted with the proximal impactor. The plastic part of the impactor enables material-preserving implantation.

Precise, axially correct seating of the component must be checked with image intensifier fluoroscopy.



Modulator proximal

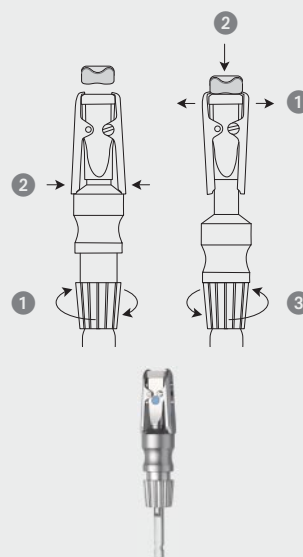

Positioner proximal



Impactor proximal

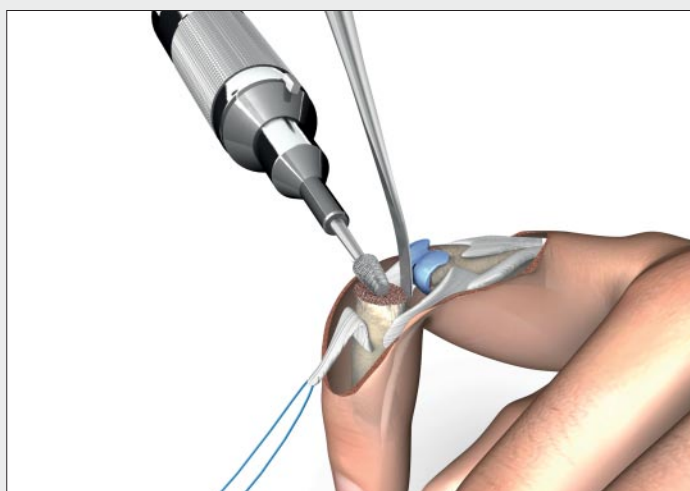

#### Resection of the articular surface of the middle phalanx

The central slip can be snared and held back with retaining suture.

Initially, small lateral osteophytes are removed with the Luer bone rongeur and then the middle phalanx is flexed to almost 90°.

Using the reamer or the Luer bone rongeur, a flat surface is made in order to create a cancellous bone bed for the distal prosthetic component.

Resection must be conducted in such a way that the collateral ligaments remain as intact as possible.

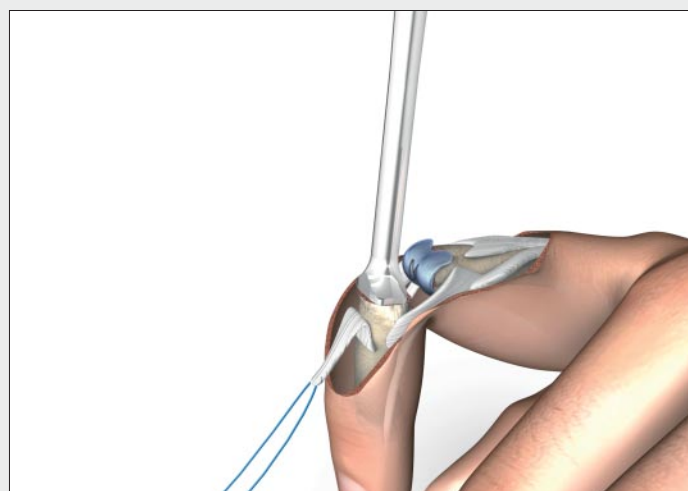

#### Preparing the distal prosthesis bed

For optimal determination of distal prosthesis size the special size determination instrument (3 spikes) is inserted into the bone. The sizer is available in all sizes (S, M, L).

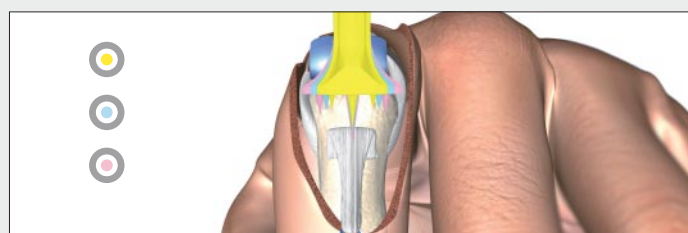

Consequently, in addition to size determination, the perforation is made for the prosthesis spikes.

The distal prosthetic component selected should be as large as possible to prevent the implant from subsidence. Cortical support of the trial instrument should therefore be on at least 3 points. In addition, care must be taken to ensure correct rotation of the distal component.



Sizer distal



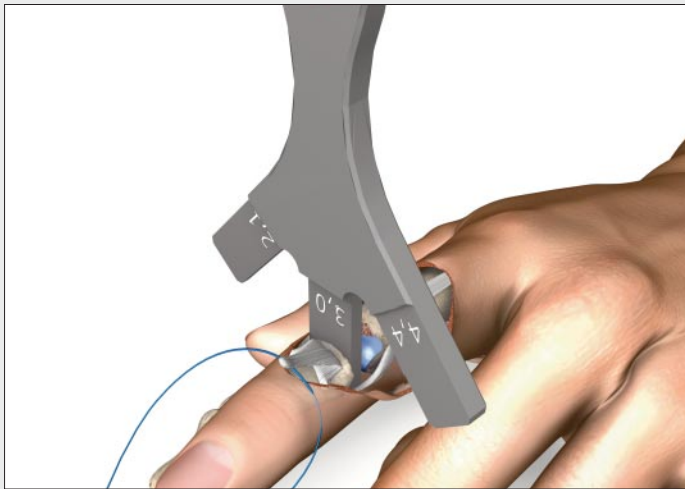

**Determination of prosthesis thickness  
(height of the polyethylene insert)**

The optimal height of the distal component (height of the polyethylene insert) is determined with the height determination instrument.

There are three heights to choose from (2.1, 3.0 and 4.4 mm).

With the extended finger the arms of the height determination instrument are placed in the resection gap until lateral play is optimally restricted.

The figure on the selected arm provides feedback for prosthesis height selection.



Height determiner distal

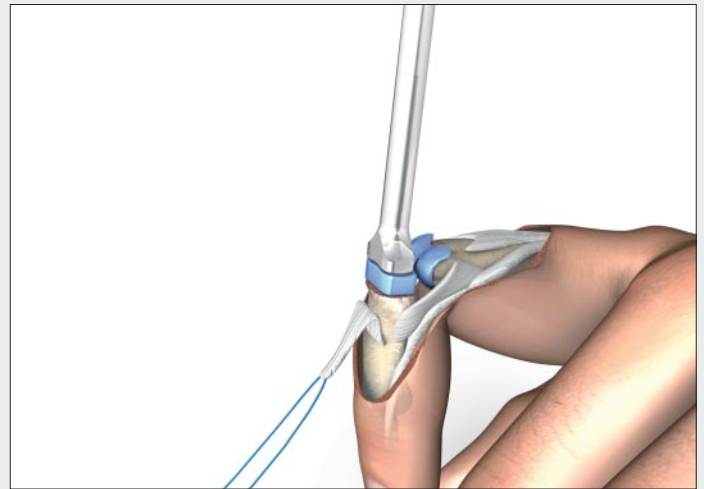

**Inserting the distal trial prosthesis**

The distal trial prosthesis is brought into position with the impactor.

Precise, axially correct seating of the component must be checked with image intensifier fluoroscopy.



Impactor distal

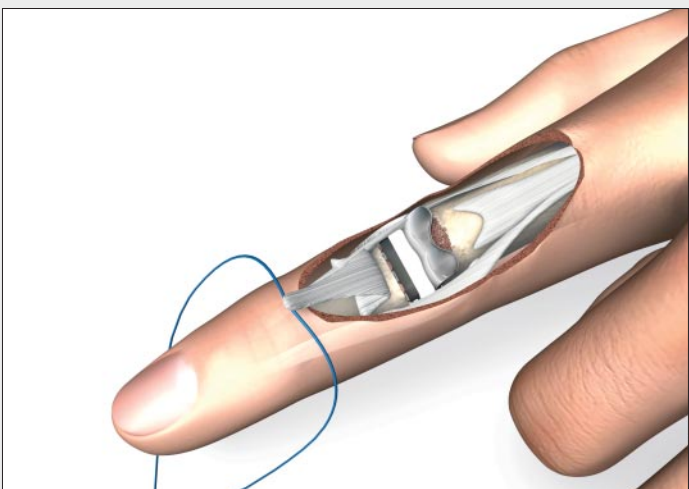
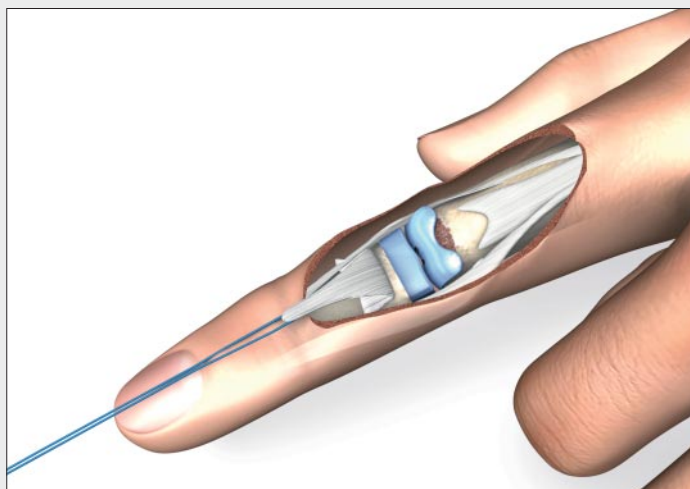

**Function test**

If the central slip is pulled proximally, the finger should be capable of complete extension. An extension deficit indicates that there is insufficient space - overextension capability must be avoided at all costs and compensated with a thicker polyethylene insert. In addition, it must be possible to passively flex the finger with minimal effort.

Lateral play should be reduced to a minimum but a passive lateral fold-up capability of approx. 10° to radial and ulnar should be permitted.

The position and orientation of the two prosthetic components are finally checked under fluoroscopic control.

**Removing the trial prosthesis and implanting the final prosthesis**

Now the trial prostheses are removed.

Then the prosthetic components, which are supplied in sterile packaging, are implanted in a material-preserving manner.



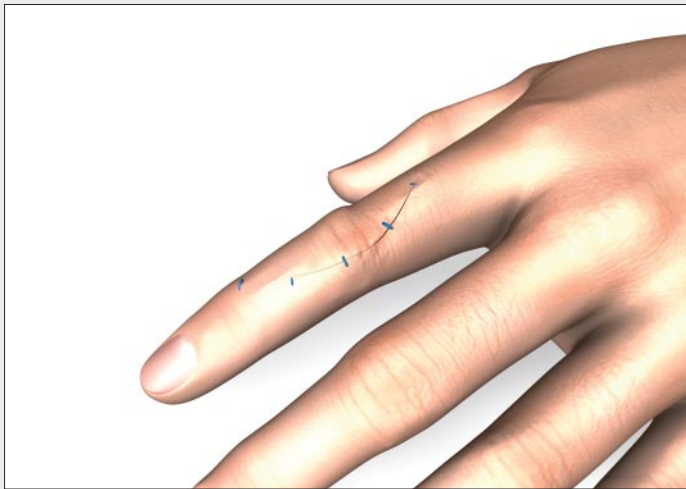

### Suture of the central slip and skin closure

To be able to ensure early functional rehabilitation, the extensor mechanism must be closed in such a way that suture insufficiency is prevented.

The aim should be to provide anatomical closure using recessed suture (suture material 3/0 or 4/0).

In a central approach with tendon splitting the transosseous reinsertion of the central slip must be performed at the base of the middle phalanx.

Following suture of the central slip, possible suture insufficiency should be checked by passive mobilization with the finger fully flexed.

The final step is skin closure.

### Postoperative treatment

Initial immobilization for a few days on a palmar long finger splint is recommended for the purpose of wound healing, edema prophylaxis, and postoperative pain treatment.

The aim then is early functional active and passive mobilization of the affected finger in order to prevent tendon adhesions.

#### *3<sup>rd</sup>-7<sup>th</sup> postoperative days:*

First change of dressing and start of active and passive mobilization exercises, with ergotherapeutic guidance if necessary.

Fitting of a palmar flexor support splint for protection (away from home and at night).

#### *From 3<sup>rd</sup> postoperative week:*

During the day: no support splint, active free mobilization. For protection, a twin dressing is fitted on the adjacent finger.

If there is a substantial extension deficit ( $>20^\circ$ ), a dynamic extension splint can be fitted should the need arise.

#### *From 5<sup>th</sup> - 6<sup>th</sup> postoperative week:*

Radiological check on osseointegration. Decision concerning free functional mobilization.



#### Preoperative planning

First of all, standard X-rays of the entire hand are taken in the A/P plane, with the hand in neutral position. Besides x-rays of the affected finger are taken in the lateral plane.

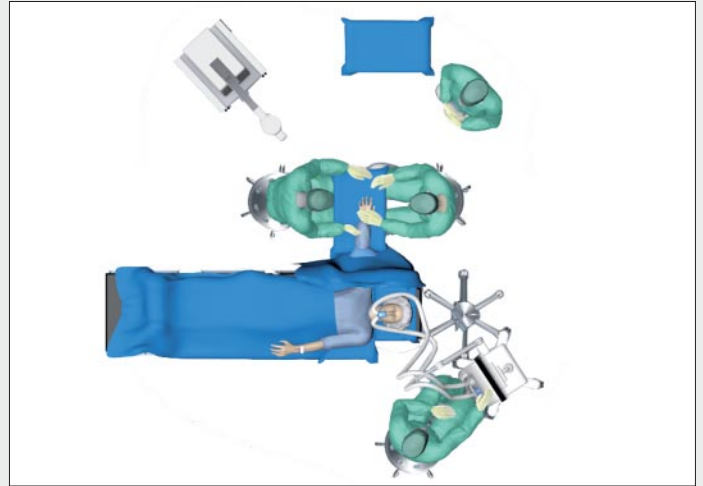

#### Patient positioning

The patient is placed in the supine position on the operating table. The hand to be operated on is placed on the extension table in the supination position of the lower arm, with the upper arm completely deprived of blood.



### Palmar skin incision

Skin incision is performed using a palmar angled incision, whereby to improve the overview the base of the skin flap comes to rest on the radial side.

Then the flexor tendon sheath tube is exposed and both neurovascular bundles are visualized and exposed.

The region of the interval between pulleys A2 and C2 is entered and a flexor tendon sheath tube is formed including the palmar plate.

In doing so, a major part of the ulnar collateral ligaments is detached from the bone directly and the radial collateral ligament with the accessory fibers is merely notched.

The joint can now be completely folded up to the dorsal side. Large projecting osteophytes are sparingly removed with the Luer bone rongeur. The head of the proximal phalanx can thus be exposed and prepared for the first resection.

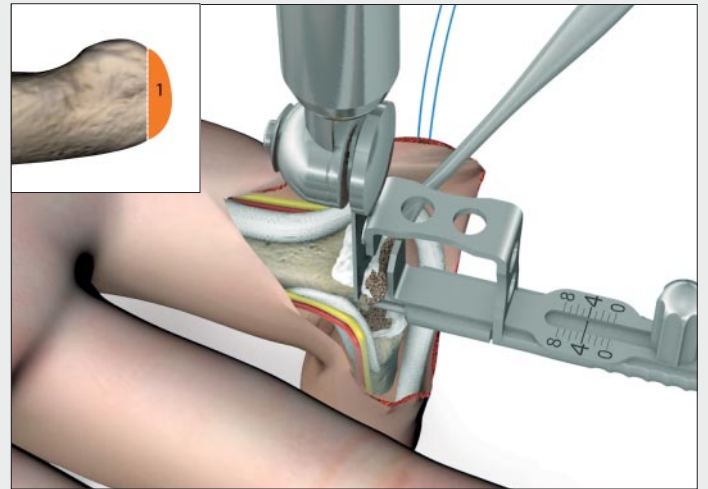

### Resection of the articular surface of the proximal phalanx

The saw guide is advanced as far as it will go from distal under the proximal phalanx. Axial orientation must be correct.



By undoing the wing nuts the saw guide can be adjusted so the joint portion to be removed can be determined.

Resection of the distal articular surface from the proximal phalanx should be kept as minimal as possible. Based on experience, approximately 4 mm must be removed.

Using a motorized saw the distal articular surface of the proximal phalanx is removed. In doing so, the saw guide serves to guide resection and it is removed as soon as saw blade guidance proves to be good. Resection is then completed freehand.



Palmar saw guide

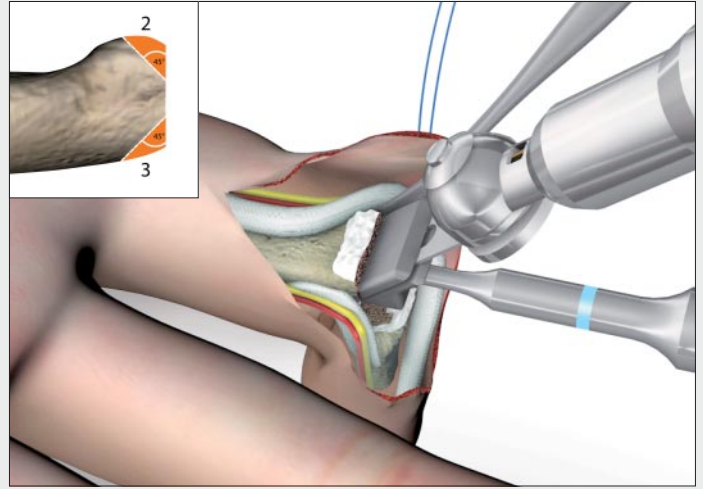
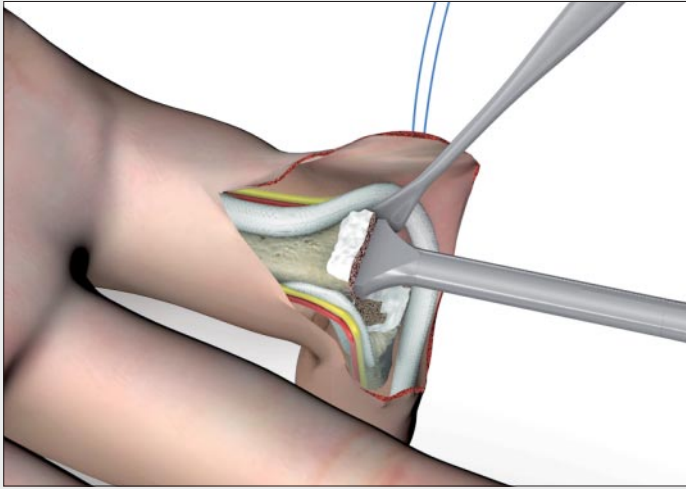

#### Determining the size of the proximal prosthetic component

To optimally determine the proximal size of the prosthesis the special size determination instrument (2 spikes) is inserted into the bone. The sizer is available in all sizes (S, M, L).



Determination of prosthesis size primarily depends on the width of the bone.

The proximal component should be kept as small as possible in order to prevent soft tissue irritation.

#### Precontouring of proximal prosthesis seat

When the proximal prosthesis size has been determined, two more steps are performed on the proximal phalanx.

For this purpose the 45° saw log is inserted in the bone via the existing stitch channel. A saw blade  $\leq 0.5$  mm thick is introduced via the guide slot in the saw log. Bone is removed on the dorsal and palmar sides, each at an angle of 45°.

In addition, any remaining palmar osteophytes can now be removed.



Sizer proximal

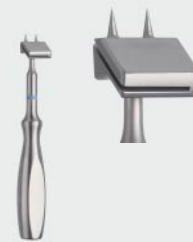

45° saw log proximal



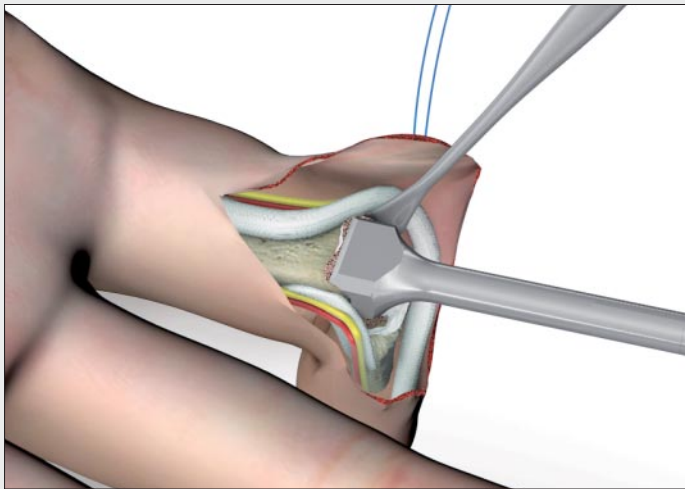

### Finishing the proximal prosthesis seat

Using the modulator, which has the internal contour of the proximal prosthetic component, a precision-fit prosthesis seat is prepared and modeled.

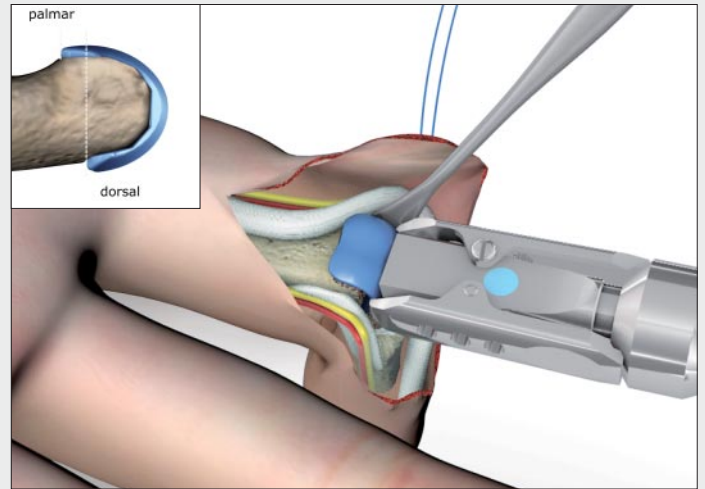

### Inserting the proximal trial prosthesis

Using the positioner, which prevents the implant from tilting downward, the proximal trial prosthesis is inserted in the axially correct position.

To avoid placing the component in an incorrect position, it is essential that the recess between the condyles be dorsal.

As soon as the trial prosthesis is seated correctly on the bone, the positioner is removed and the entire component is implanted with the proximal impactor. The plastic part of the impactor enables material-preserving implantation.

Precise, axially correct seating of the component must be checked with image intensifier fluoroscopy.



Modulator proximal

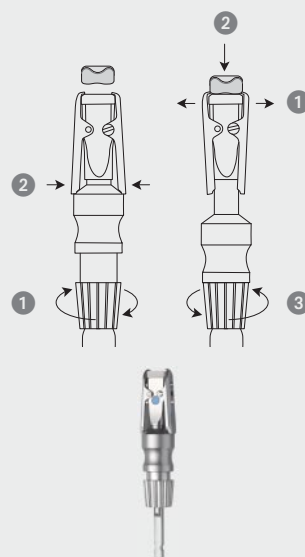

Positioner proximal



Impactor proximal

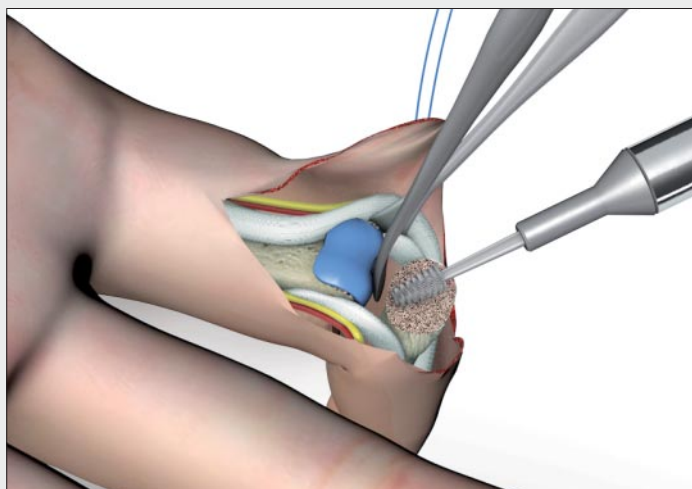

#### Resection of the articular surface of the middle phalanx

Initially, small lateral osteophytes are removed with the Luer bone rongeur and then the base of the middle phalanx is well exposed due to complete overextension of the finger. If there are large osteophytes on the dorsal side at the attachment of the central slip, the latter is sparingly detached from the bone and the osteophyte is removed with the Luer bone rongeur.

Using the reamer or the Luer bone rongeur, a flat surface is made in order to create a cancellous bone bed for the distal prosthetic component.

Resection must be conducted in such a way that the collateral ligaments remain as intact as possible.

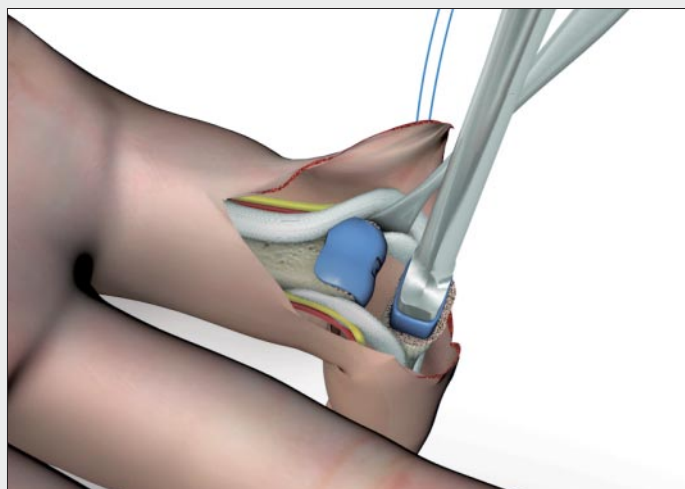

#### Preparing the distal prosthesis bed

For optimal determination of distal prosthesis size the special size determination instrument (3 spikes) is inserted into the bone. The sizer is available in all sizes (S, M, L)

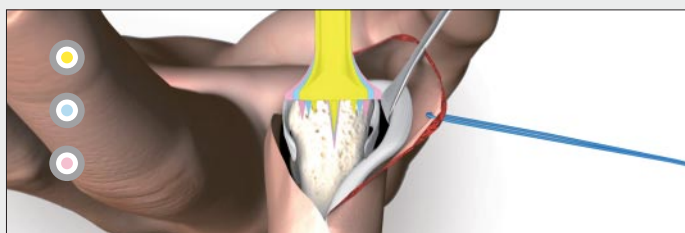

Consequently, in addition to size determination, the perforation is made for the prosthesis spikes.

The distal prosthetic component selected should be as large as possible to prevent the implant from subsidence. Cortical support of the trial instrument should therefore be on at least 3 points. In addition, care must be taken to ensure correct rotation of the distal component.



Sizer distal



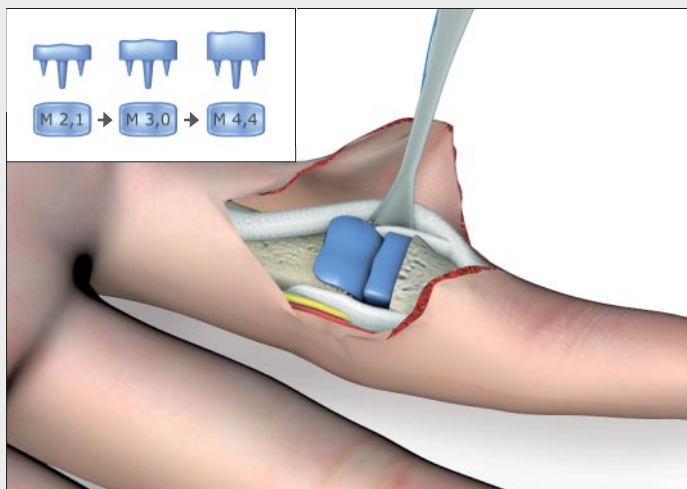

#### Determination of prosthesis thickness (height of the polyethylene insert)

The height determination instrument enclosed with the system cannot be used with the palmar approach. Therefore it is advisable to initially use the appropriate trial prosthesis with the lowest height (2.1 mm) in order to determine the optimal height of the distal component (height of the polyethylene insert). There are three heights to choose from (2.1, 3.0 and 4.4 mm).

Following reduction with the trial components the tension achieved can be clinically assessed. In view of postoperative scar healing with limited mobility it is advisable to set only moderate tension. If in clinical terms tension proves to be insufficient, it is advisable to switch to the next larger trial prosthesis (3.0 or 4.4 mm). If after reduction with the lowest component height tension is very high, it is recommended that slightly more resection be performed distally.

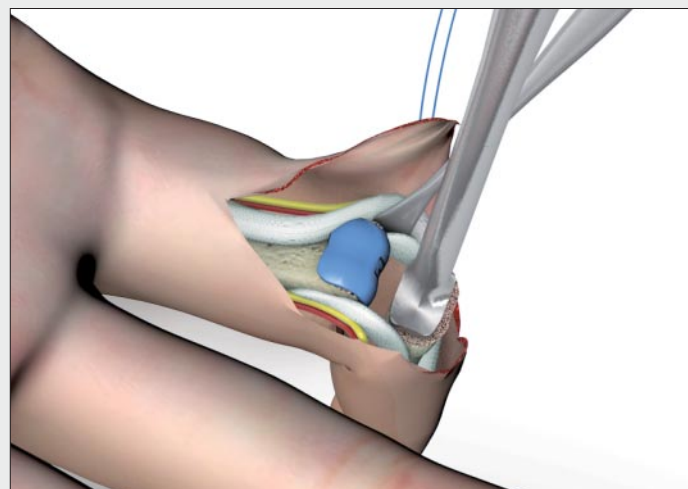

#### Inserting the distal trial prosthesis

The distal trial prosthesis is brought into position with the impactor.

Precise, axially correct seating of the component must be checked with image intensifier fluoroscopy.



Impactor distal

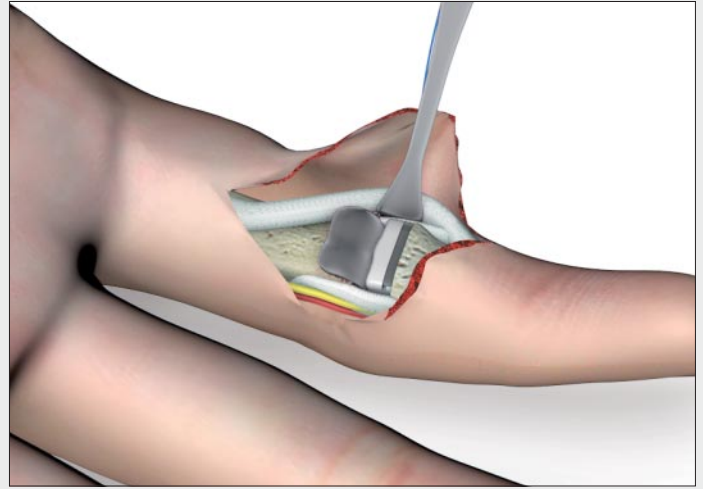
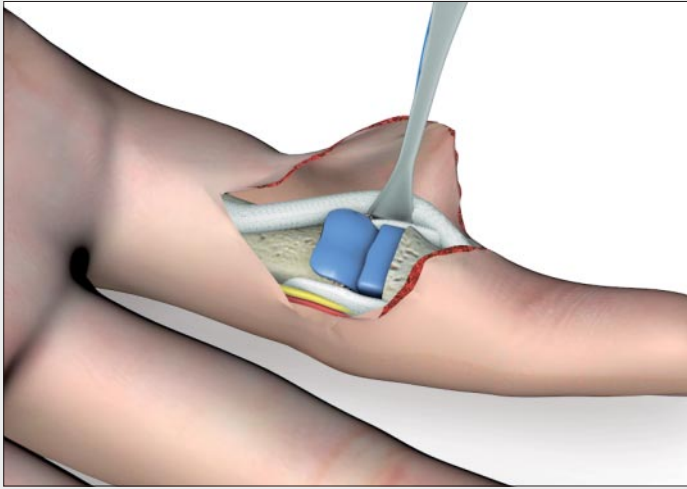

### Function test

When both prosthetic components have been inserted, it should be possible to passively flex the finger with minimal effort.

Lateral play should be reduced to a minimum but a passive lateral fold-up capability of approx. 10° to radial and ulnar should be permitted.

An extension deficit indicates that there is insufficient space – overextension capability must be avoided at all costs and compensated with a thicker polyethylene insert.

The position and orientation of the two prosthetic components are finally checked under fluoroscopic control.

### Removing the trial prosthesis and implanting the final prosthesis

Now the trial prostheses are removed.

Then the prosthetic components, which are supplied in sterile packaging, are implanted in a material-preserving manner.



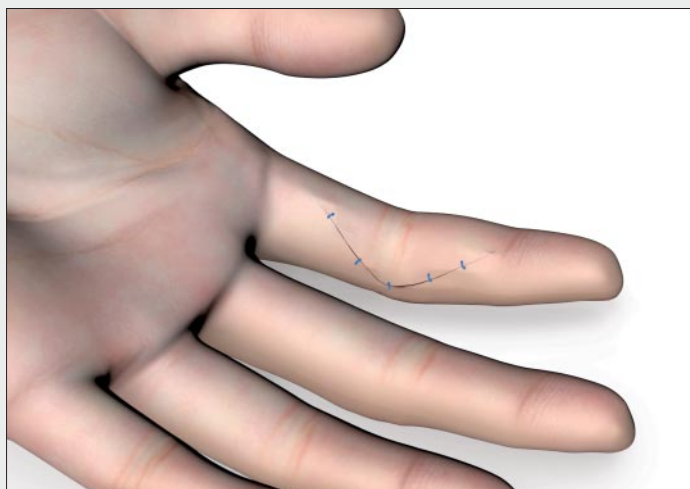

### Refixation of the flexor tendon tube and skin closure

After complete reduction of the finger the flexor tendon tube automatically resumes its anatomical position. To close the pulley system, first the fibers between pulleys A2 and C2 are proximally readapted. Then the fibers of the flexor tendon tube with the accessory collateral ligaments are each sutured laterally on the ulnar and radial sides (suture material 4/0 or 5/0).

This results in complete refixation of the entire flexor tendon tube.

The final step is skin closure.



### Postoperative treatment

Initial immobilization for a few days on a palmar long finger splint is recommended for the purpose of wound healing, edema prophylaxis, and postoperative pain treatment.

The aim then is early functional active and passive mobilization of the affected finger in order to prevent tendon adhesions.

*3<sup>rd</sup>-7<sup>th</sup> postoperative days:*

First change of dressing and start of active and passive mobilization exercises, with ergotherapeutic guidance if necessary.

Fitting of a palmar flexor support splint for protection (away from home and at night).

*From 3<sup>rd</sup> postoperative week:*

During the day: no support splint, active free mobilization. For protection, a twin dressing is fitted on the adjacent finger.

If there is a substantial extension deficit ( $>20^\circ$ ), a dynamic extension splint can be fitted should the need arise.

*From 5<sup>th</sup> - 6<sup>th</sup> postoperative week:*

Radiological check on osseointegration. Decision concerning free functional mobilization.

## Implants **CapFlex** PIP

**Implants CapFlex PIP, proximal**



Ti CCr  
1 unit(s)  
**STERILE | R**

Art. No.	Description
26-100-01-04	CapFlex PIP, proximal, S
26-100-02-04	CapFlex PIP, proximal, M
26-100-03-04	CapFlex PIP, proximal, L

**Implants CapFlex PIP, distal**







Ti CCr  
Pe 1 unit(s)  
**STERILE | R**

Art. No.	Description
26-100-11-04	CapFlex PIP, distal, S, height 2.1 mm
26-100-12-04	CapFlex PIP, distal, S, height 3.0 mm
26-100-21-04	CapFlex PIP, distal, M, height 2.1 mm
26-100-22-04	CapFlex PIP, distal, M, height 3.0 mm
26-100-23-04	CapFlex PIP, distal, M, height 4.4 mm
26-100-31-04	CapFlex PIP, distal, L, height 2.1 mm
26-100-32-04	CapFlex PIP, distal, L, height 3.0 mm
26-100-33-04	CapFlex PIP, distal, L, height 4.4 mm







Explanation of icons

-  Titanium
-  Cobalt-chromium
-  UHMWPe
-  Packaging unit

**STERILE**  Sterile packaged implants

**Possible combinations of individual components**

	CapFlex PIP proximal <b>S</b>	CapFlex PIP proximal <b>M</b>	CapFlex PIP proximal <b>L</b>
CapFlex PIP, <b>distal, S</b> , height 2.1 mm CapFlex PIP, <b>distal, S</b> , height 3.0 mm			
CapFlex PIP, <b>distal, M</b> , height 2.1 mm CapFlex PIP, <b>distal, M</b> , height 3.0 mm CapFlex PIP, <b>distal, M</b> , height 4.4 mm			
CapFlex PIP, <b>distal, L</b> , height 2.1 mm CapFlex PIP, <b>distal, L</b> , height 3.0 mm CapFlex PIP, <b>distal, L</b> , height 4.4 mm			

## Instruments **CapFlex** PIP

### General instruments



26-101-78-07  
Saw guide  
dorsal  
15 cm / 5 7/8"



26-101-79-07  
Saw guide  
palmar  
15 cm / 5 7/8"



26-101-80-07  
Height determiner distal  
11 cm / 4 3/8"





Explanation of icons

-  Steel
-  Silicone
-  Packaging unit



1/2

26-101-81-07  
Periosteal  
elevator  
17 cm / 6 5/8"



1/2



26-950-11-07  
Handle AO  
12 cm / 4 5/8"



## Instruments **CapFlex** PIP

Size-dependent instruments  
Size S

**Trial prosthesis**

Art. No.	Description
26-101-01-09	CapFlex trial prosthesis proximal, S
26-101-11-09	CapFlex trial prosthesis distal, S 2.1
26-101-12-09	CapFlex trial prosthesis distal, S 3.0



26-101-50-07  
Sizer  
proximal  
17.5 cm / 6 7/8"



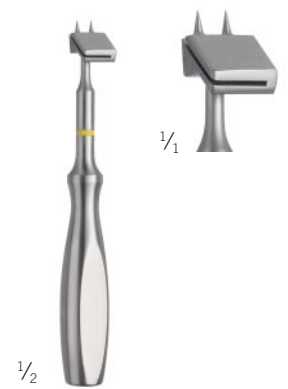



26-101-54-07  
Saw log 45°  
proximal  
10 cm / 3 7/8"







Explanation of icons

-  Yellow color code: size S
-  Ti Titanium
-  St Steel
-  Sic Silicone
-  1 unit



26-101-58-07  
Modulator  
proximal  
17.5 cm / 6 7/8"



26-101-62-07  
Positioner  
proximal  
9 cm / 3 4/8"



26-101-66-07  
Impactor  
proximal  
17.5 cm / 6 7/8"



26-101-70-07  
Sizer  
distal  
17.5 cm / 6 7/8"





26-101-74-07  
Impactor  
distal  
17.5 cm / 6 7/8"



## Instruments **CapFlex** PIP

Size-dependent instruments  
Size M

**Trial prosthesis**

Art. No.	Description
26-101-02-09	CapFlex trial prosthesis proximal, M
26-101-21-09	CapFlex trial prosthesis distal, M 2.1
26-101-22-09	CapFlex trial prosthesis distal, M 3.0
26-101-23-09	CapFlex trial prosthesis distal, M 4.4



26-101-51-07  
Sizer  
proximal  
17.5 cm / 6 7/8"



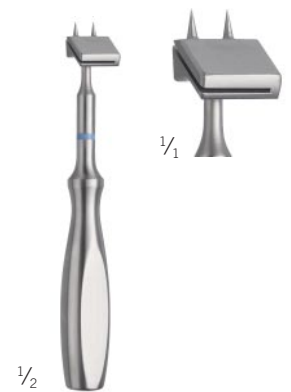



26-101-55-07  
Saw log 45°  
proximal  
10 cm / 3 7/8"





Explanation of icons

-  Blue color code: size M
-  Titanium
-  Steel
-  Silicone
-  1 unit(s)



1/2

1/2

26-101-59-07  
Modulator  
proximal  
17.5 cm / 6 7/8"



1/2

26-101-63-07  
Positioner  
proximal  
9 cm / 3 4/8"



1/2

1/2

26-101-67-07  
Impactor  
proximal  
17.5 cm / 6 7/8"



1/2

1/2

26-101-71-07  
Sizer  
distal  
17.5 cm / 6 7/8"



1/2

1/2



26-101-75-07  
Impactor  
distal  
17.5 cm / 6 7/8"



## Instruments **CapFlex** PIP

Size-dependent instruments  
Size L

**Trial prosthesis**

Art. No.	Description
26-101-03-09	CapFlex trial prosthesis proximal, L
26-101-31-09	CapFlex trial prosthesis distal, L 2.1
26-101-32-09	CapFlex trial prosthesis distal, L 3.0
26-101-33-09	CapFlex trial prosthesis distal, L 4.4



26-101-52-07  
Sizer  
proximal  
17.5 cm / 6 7/8"



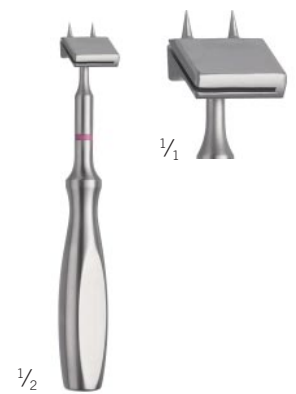



























26-101-56-07  
Saw log 45°  
proximal  
10 cm / 3 7/8"





Explanation of icons

-  Pink color code: size L
-  Ti Titanium
-  St Steel
-  Sic Silicone
-  1 unit

 <p>1/2</p>	 <p>1/2</p>	 <p>1/2</p>	 <p>1/2</p>	 <p>1/2</p>
<p>26-101-60-07 Modulator proximal 17.5 cm / 6 7/8"</p> <p>   </p>	<p>26-101-64-07 Positioner proximal 9 cm / 3 4/8"</p> <p>  </p>	<p>26-101-68-07 Impactor proximal 17.5 cm / 6 7/8"</p> <p>   </p>	<p>26-101-72-07 Sizer distal 17.5 cm / 6 7/8"</p> <p>   </p>	<p>26-101-76-07 Impactor distal 17.5 cm / 6 7/8"</p> <p>   </p>

## Storage **CapFlex** PIP

The CapFlex stainless steel storage system is of honeycomb design, which is characterized by high stability and low weight. The large openings allow optimal reprocessing.

The storage system is drawer-based, which enables equally optimal access to all sizes of instrument.

The general, size-independent instruments are stored in the first drawer. The size-dependent instruments including the various trial prostheses are stored below: The second drawer contains instruments in size L, the third drawer contains instruments in size M, and the fourth drawer contains instruments in size S. The drawers of the size-dependent instruments are marked with the respective size.

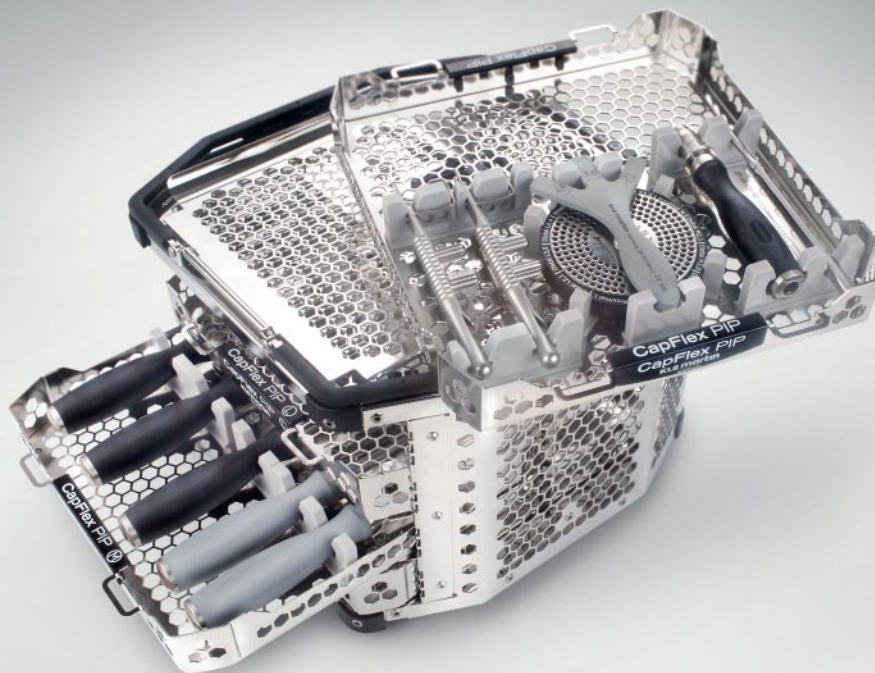

### Storage

55-910-03-04	Storage system comprised of:
	Housing and one drawer insert each for
	- General instruments (incl. rack for trial implants)
	- Instruments in size L
	- Instruments in size M
	- Instruments in size S



55-910-04-04  
Housing

1  
unit(s)



55-910-05-04  
Drawer insert  
general instruments

1  
unit(s)



55-910-08-04  
Drawer insert  
instruments in size L

1  
unit(s)



55-910-07-04  
Drawer insert  
instruments in size M

1  
unit(s)



55-910-06-04  
Drawer insert  
instruments in size S

1  
unit(s)



55-910-09-04  
Rack for trial  
implants

1  
unit(s)

## KLS Martin Group

### **KLS Martin Australia Pty Ltd.**

Sydney · Australia  
Tel. +61 2 9439 5316  
australia@klsmartin.com

### **KLS Martin India Pvt Ltd.**

Chennai · India  
Tel. +91 44 66 442 300  
india@klsmartin.com

### **Martin Nederland/Marned B.V.**

Huizen · The Netherlands  
Tel. +31 35 523 45 38  
nederland@klsmartin.com

### **KLS Martin LP**

Jacksonville · Florida, USA  
Tel. +1 904 641 77 46  
usa@klsmartin.com

### **KLS Martin do Brasil Ltda.**

São Paulo · Brazil  
Tel. +55 11 3554 2299  
brazil@klsmartin.com

### **Martin Italia S.r.l.**

Milan · Italy  
Tel. +39 039 605 67 31  
italia@klsmartin.com

### **Gebrüder Martin GmbH & Co. KG**

Moscow · Russia  
Tel. +7 499 792-76-19  
russia@klsmartin.com

### **Gebrüder Martin GmbH & Co. KG**

Shanghai · China  
Tel. +86 21 5820 6251  
china@klsmartin.com

### **Nippon Martin K.K.**

Tokyo · Japan  
Tel. +81 3 3814 1431  
nippon@klsmartin.com

### **Gebrüder Martin GmbH & Co. KG**

Dubai · United Arab Emirates  
Tel. +971 4 454 16 55  
middleeast@klsmartin.com

### **KLS Martin France SARL**

Mulhouse · France  
Tel. +33 3 8951 3150  
france@klsmartin.com

### **KLS Martin SE Asia Sdn. Bhd.**

Penang · Malaysia  
Tel. +604 505 7838  
malaysia@klsmartin.com

### **KLS Martin UK Ltd.**

London · United Kingdom  
Tel. +44 1189 000 570  
uk@klsmartin.com

### **Gebrüder Martin GmbH & Co. KG**

#### **A company of the KLS Martin Group**

KLS Martin Platz 1 · 78532 Tuttlingen · Germany  
P.O. Box 60 · 78501 Tuttlingen · Germany  
Tel. +49 7461 706-0 · Fax +49 7461 706-193  
info@klsmartin.com · www.klsmartin.com

